

# GF705

## MagnetoResistive Magnetic Field Sensor

The GF705 is a magnetic field sensor based on the multilayer Giant MagnetoResistive (GMR) effect. The Sensor contains a Wheatstone bridge with on-chip flux concentrators to improve the sensitivity. The sensor is ideal for measuring magnetic fields in a linear range from 1.8 mT up to 8 mT.

A typical application is endpoint detection through a cylinder of stainless steel: A moving magnet inside a thick-walled cylinder is detected by a GF705 sensor from the outside.

The GF705 is available as bond version (bare die) and as flip-chip or LGA-package for SMD assembly.

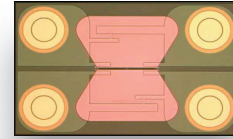

### Product Overview GF705

Article description	Package	Delivery Type
GF705APA-AE	Flip-chip	Tape on reel (5000)
GF705ACA-AB	Die on wafer <sup>1)</sup>	Waferbox
GF705AMA-AE	LGA6S	Tape on reel (2500)

<sup>1)</sup> Minimum order quantities apply.

### Quick Reference Guide

Symbol	Parameter	Min.	Typ.	Max.	Unit
V <sub>CC</sub>	Supply voltage	-	5.0	-	V
B <sub>Lin</sub>	Linear magnetic range	1.8	-	8.0	mT
S	Sensitivity (in linear range)	8	10	13	mV/V/mT
R <sub>B</sub>	Bridge resistance	4.0	5.0	7.0	kΩ

### Absolute Maximum Ratings

In accordance with the absolute maximum rating system (IEC60134).

Symbol	Parameter	Min.	Max.	Unit
V <sub>CC</sub>	Supply voltage	-9.0	+9.0	V
T <sub>amb</sub>	Ambient temperature	-40	+125	°C

Stresses beyond those listed under "Absolute maximum ratings" may cause permanent damage to the device. This is a stress rating only and functional operation of the device at these or any other conditions beyond those indicated in the operational sections of this specification is not implied. Exposure to absolute maximum rating conditions for extended periods may affect device reliability.

### Features

- Based on the GiantMagnetoResistive (GMR) effect
- Flip-chip assembly (BGA)
- Temperature range from -40 °C to +125 °C

### Advantages

- Large working distance
- Excellent absolute accuracy
- Large range of magnetic field strength
- Very small size
- Contactless field measuring
- Switching with adjustable switching thresholds

### Applications

- Endpoint detection in cylinders
- Reference monitoring
- Magnetic switches



### Magnetic Data

Symbol	Parameter	Conditions	Min.	Typ.	Max.	Unit
$B_{Lin}$	Linear magnetic flux density range (abs)	See Fig.1	1.8	-	8.0	mT
$B_{sat}$	Saturation magnetic flux density <sup>1)</sup>	See Fig.1	-	±25	-	mT

<sup>1)</sup> At  $B_{sat}$  the sensor delivers the maximal output voltage  $V_{peak}$ . By exceeding the value of  $B_{sat}$  the output signal is no longer unique.

### Electrical Data

$T_{amb} = 25\text{ °C}$ ; unless otherwise specified.

Symbol	Parameter	Conditions	Min.	Typ.	Max.	Unit
$V_{CC}$	Supply voltage		-	5.0	-	V
S	Sensitivity	$B = (1.8...8)\text{ mT}$	8	10	13	mV/V/mT
$TC_S$	Temperature coefficient of Sensitivity <sup>2)</sup>	$T_{amb} = (-40...+125)\text{ °C}$	-0.26	-0.22	-0.18	%/K
$R_B$	Bridge resistance <sup>3)</sup>		4.0	5.0	7.0	kΩ
$TC_{RB}$	Temperature coefficient of RB <sup>4)</sup>	$T_{amb} = (-40...+125)\text{ °C}$	0.17	0.20	0.23	%/K
$V_{peak}$	Maximum output voltage <sup>5)</sup>	See Fig.1	-	110	-	mV/V
$V_{OUT}$	Voltage output delta <sup>6)</sup> $V_{OUT(3\text{ mT})} - V_{OUT(0\text{ mT})}$	0 mT @ 90 deg 3 mT @ 0 deg	12.3	-	27.4	mV/V

<sup>2)</sup>  $TC_S = 100 \cdot \frac{S_{(T_2)} - S_{(T_1)}}{S_{(T_1)} \cdot (T_2 - T_1)}$  with  $T_1 = 25\text{ °C}$ ;  $T_2 = 125\text{ °C}$ .

<sup>3)</sup> Bridge resistance between pads 1 and 3 and 2 and 4.

<sup>4)</sup>  $TC_{RB} = 100 \cdot \frac{R_{B(T_2)} - R_{B(T_1)}}{R_{B(T_1)} \cdot (T_2 - T_1)}$  with  $T_1 = 25\text{ °C}$ ;  $T_2 = 125\text{ °C}$ .

<sup>5)</sup> Maximal output voltage at  $B_{sat}$ .

<sup>6)</sup> Parameter checked on 96 samples.

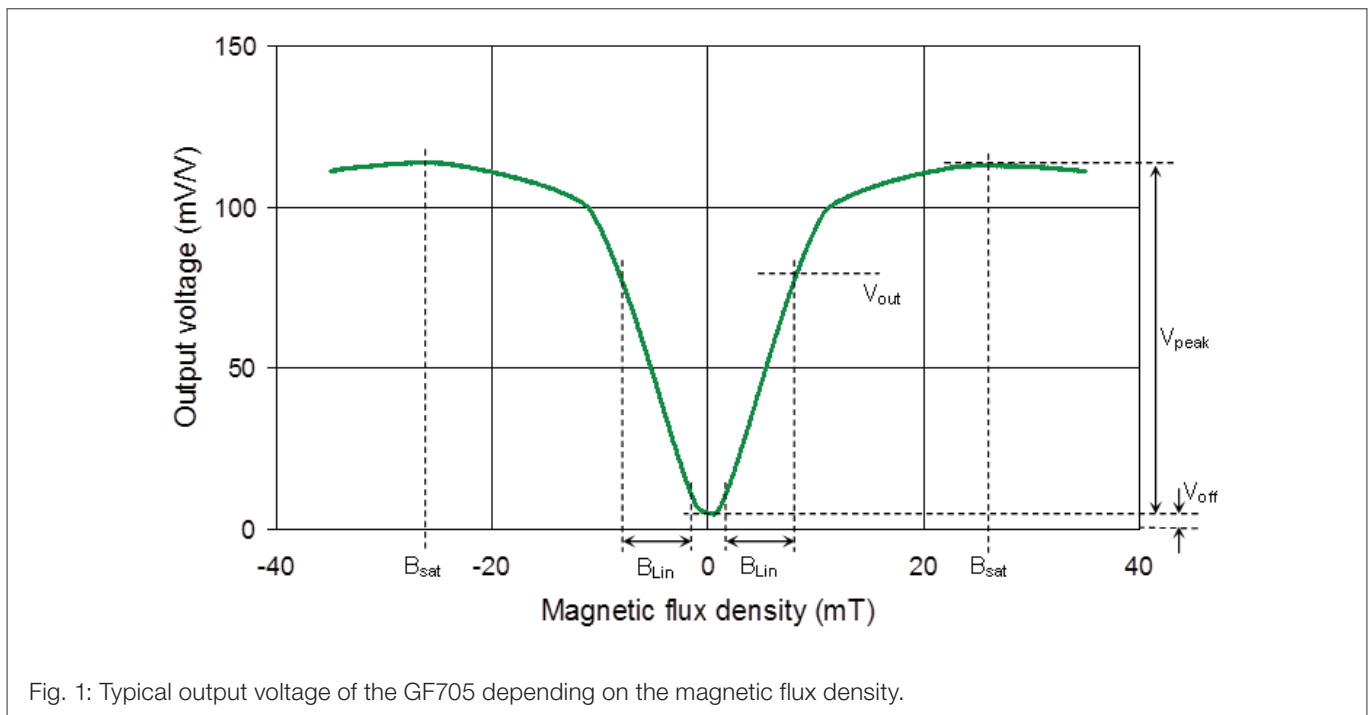

Fig. 1: Typical output voltage of the GF705 depending on the magnetic flux density.

**Accuracy**

$T_{amb} = 25\text{ }^{\circ}\text{C}$ ; unless otherwise specified.

Symbol	Parameter	Conditions	Min.	Typ.	Max.	Unit
$V_{off}$	Offset voltage per $V_{CC}$	See Fig. 1	-5.0	-	+5.0	mV/V
$TC_{Voff}$	Temperature coefficient of $V_{off}$	$T_{amb} = (-40\dots+125)\text{ }^{\circ}\text{C}$	-20	7	+25	$\mu\text{V/V/K}$
$\epsilon_{Lin}$	Linearity error	$B = (1.8\dots 8)\text{ mT}$ ; see Fig. 2	-	2	5	% of $V_{out}$
$H_C$	Hysteresis error <sup>1)</sup>	See Fig. 3	-	0.05	0.1	mT

<sup>1)</sup> The hysteresis error is ascertained in the magnetic field, ramped from 10 mT to -10 mT and back to 10 mT. The value is specified for the linear range  $B_{Lin}$ .

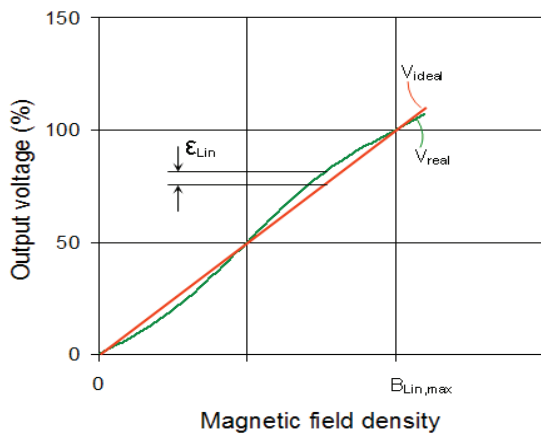

Fig. 2: Definition of linearity error  $\epsilon_{Lin}$  (schematic).

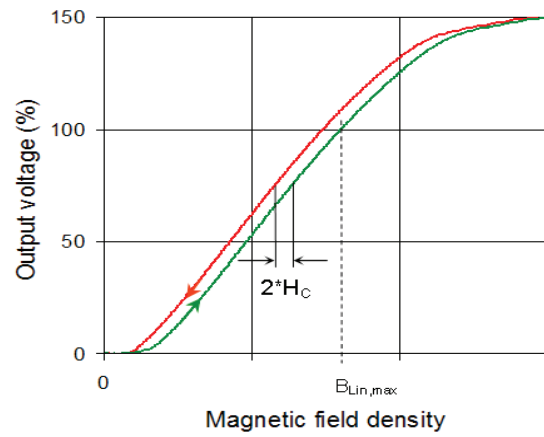

Fig. 3: Definition of hysteresis error  $H_C$  (schematic).

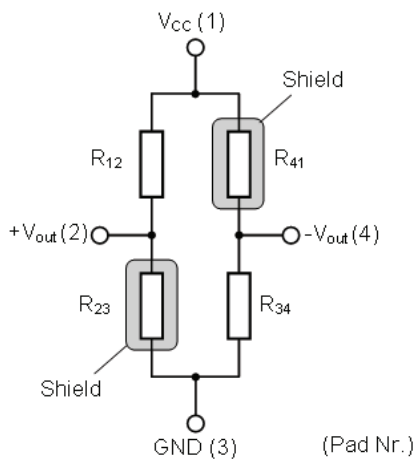

Fig. 4: Simplified circuit diagram.

In Fig. 4 the resistors  $R_{23}$  and  $R_{41}$  are covered by two flux concentrators (shields) to prevent an applied magnetic field from influencing them. Therefore, when a field is applied, the resistors  $R_{12}$  and  $R_{34}$  decrease in resistance, while the other two resistors under the flux concentrator do not. This imbalance leads to the bridge output.

## GF705 as Bare Die and Flip-Chip

### Pinning

Pad	Symbol	Parameter
1	$V_{CC}$	Supply voltage
2	$+V_{out}$	Positive output voltage
3	GND	Ground
4	$-V_{out}$	Negative output voltage

Note:

Pin 1 is not marked on the chip. Since the chip is symmetrical, its orientation is only defined by its long and short side.

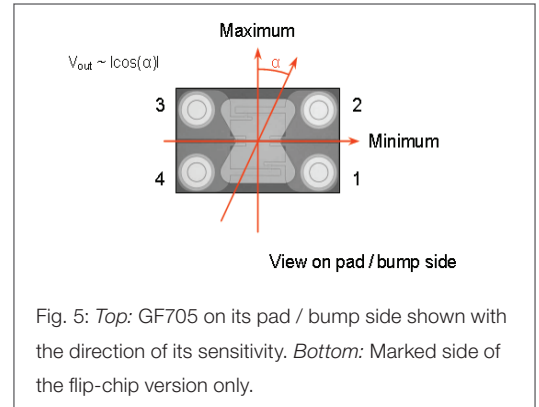

### Mechanical Data

Symbol	Parameter	Min.	Typ.	Max.	Unit	
A	Bare die	Length	1435	1460	1485	$\mu\text{m}$
B		Width	935	960	985	$\mu\text{m}$
C		Height	240	250	260	$\mu\text{m}$
d		Diameter	-	230	-	$\mu\text{m}$
A	Flip-chip	Length	1425	1460	1485	$\mu\text{m}$
B		Width	935	960	985	$\mu\text{m}$
C		Height	400	410	420	$\mu\text{m}$
d		Diameter <sup>1)</sup>	-	300	-	$\mu\text{m}$
S		Standoff <sup>2)</sup>	-	240	-	$\mu\text{m}$
a	Pitch a	-	1000	-	$\mu\text{m}$	
b	Pitch b	-	500	-	$\mu\text{m}$	
e	Margin	-	230	-	$\mu\text{m}$	

<sup>1)</sup> Diameter of solder ball before reflow.

<sup>2)</sup> After reflow.

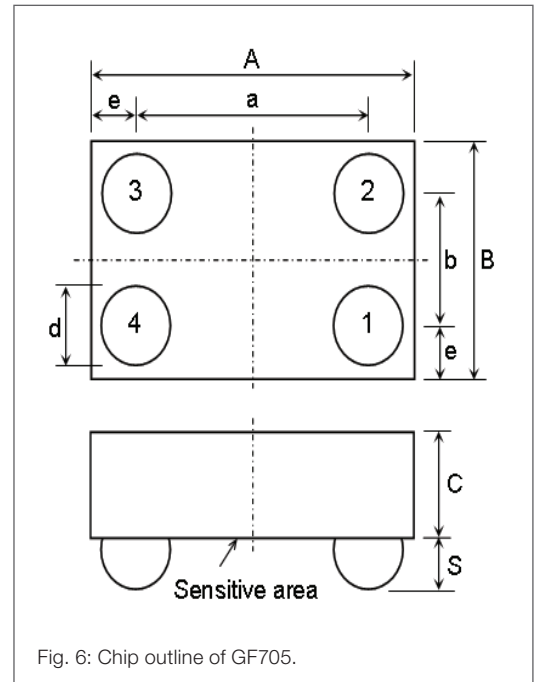

### Data for Packaging and Interconnection Technologies

Symbol	Parameter	Conditions	Value	Unit
Bare die	Pad material		Au	-
	Pad thickness		0.4	$\mu\text{m}$
Flip-chip	Solder ball material		SnAg2.6Cu0.6	-
	Maximum solder temperature	For 6 s	260	$^{\circ}\text{C}$

**GF705AMA LGA6S**

**Pinning**

Pad	Symbol	Parameter
1	+V <sub>out</sub>	Positive output voltage
2	NC	Not connected
3	GND	Ground
4	V <sub>CC</sub>	Supply voltage
5	-V <sub>out</sub>	Negative output voltage
6-8	NC	Not connected

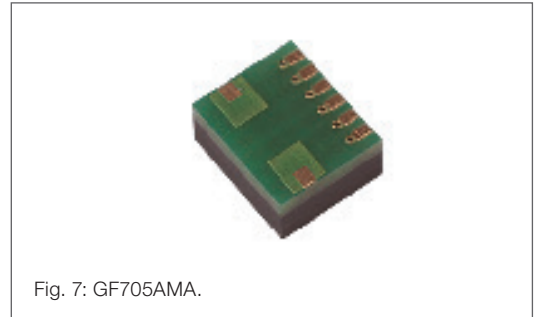

Fig. 7: GF705AMA.

**Dimensions**

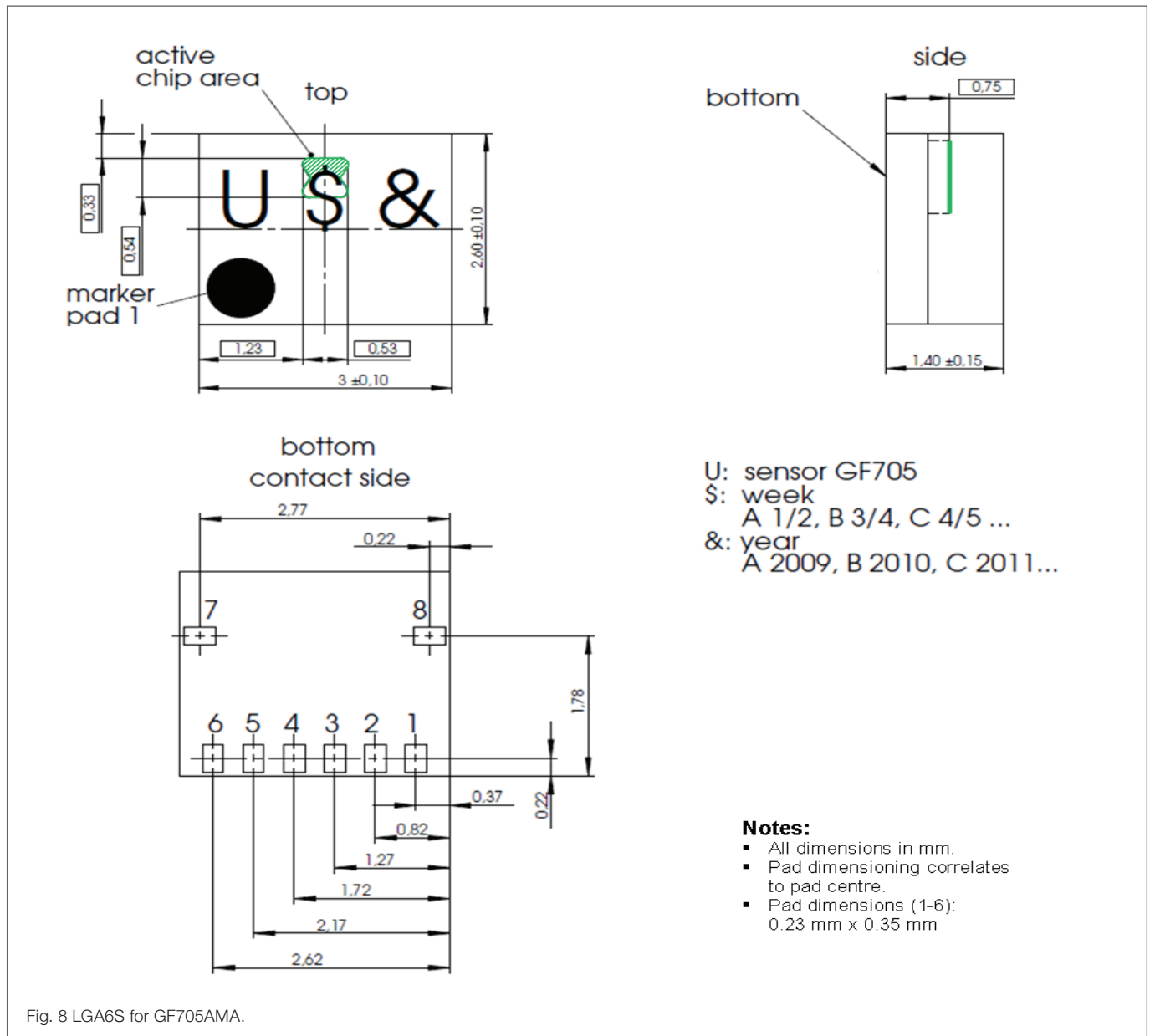

Fig. 8 LGA6S for GF705AMA.

## General Information

### Product Status

Article	Status
GF705APA-AB	The product is in series production.
GF705ACA-AB	The product is in series production.
GF705AMA-AE	The product is in series production.
<b>Note</b>	The status of the product may have changed since this data sheet was published. The latest information is available on the internet at <a href="http://www.sensitec.com">www.sensitec.com</a> .

### Disclaimer

Sensitec GmbH reserves the right to make changes, without notice, in the products, including software, described or contained herein in order to improve design and/or performance. Information in this document is believed to be accurate and reliable. However, Sensitec GmbH does not give any representations or warranties, expressed or implied, as to the accuracy or completeness of such information and shall have no liability for the consequences of use of such information. Sensitec GmbH takes no responsibility for the content in this document if provided by an information source outside of Sensitec products.

In no event shall Sensitec GmbH be liable for any indirect, incidental, punitive, special or consequential damages (including but not limited to lost profits, lost savings, business interruption, costs related to the removal or replacement of any products or rework charges) irrespective the legal base the claims are based on, including but not limited to tort (including negligence), warranty, breach of contract, equity or any other legal theory.

Notwithstanding any damages that customer might incur for any reason whatsoever, Sensitec product aggregate and cumulative liability towards customer for the products described herein shall be limited in accordance with the General Terms and Conditions of Sale of Sensitec GmbH. Nothing in this document may be interpreted or construed as an offer to sell products that is open for acceptance or the grant, conveyance or implication of any license under any copyrights, patents or other industrial or intellectual property rights.

Unless otherwise agreed upon in an individual agreement Sensitec products sold are subject to the General Terms and Conditions of Sales as published at [www.sensitec.com](http://www.sensitec.com).

#### Sensitec GmbH

Georg-Ohm-Str. 11 · 35633 Lahnau · Germany  
 Tel. +49 6441 9788-0 · Fax +49 6441 9788-17  
[www.sensitec.com](http://www.sensitec.com) · [sensitec@sensitec.com](mailto:sensitec@sensitec.com)



## General Information

### Application Information

Applications that are described herein for any of these products are for illustrative purposes only. Sensitec GmbH makes no representation or warranty – whether expressed or implied – that such applications will be suitable for the specified use without further testing or modification.

Customers are responsible for the design and operation of their applications and products using Sensitec products, and Sensitec GmbH accepts no liability for any assistance with applications or customer product design. It is customer's sole responsibility to determine whether the Sensitec product is suitable and fit for the customer's applications and products planned, as well as for the planned application and use of customer's third party customer(s). Customers should provide appropriate design and operating safeguards to minimize the risks associated with their applications and products.

Sensitec GmbH does not accept any liability related to any default, damage, costs or problem which is based on any weakness or default in the customer's applications or products, or the application or use by customer's third party customer(s). Customer is responsible for doing all necessary testing for the customer's applications and products using Sensitec products in order to avoid a default of the applications and the products or of the application or use by customer's third party customer(s).

Sensitec does not accept any liability in this respect.

### Life Critical Applications

These products are not qualified for use in life support appliances, aeronautical applications or devices or systems where malfunction of these products can reasonably be expected to result in personal injury.

### Copyright © 2018 by Sensitec GmbH, Germany

All rights reserved. No part of this document may be copied or reproduced in any form or by any means without the prior written agreement of the copyright owner. The information in this document is subject to change without notice. Please observe that typical values cannot be guaranteed. Sensitec GmbH does not assume any liability for any consequence of its use.

#### Sensitec GmbH

Georg-Ohm-Str. 11 · 35633 Lahnau · Germany  
Tel. +49 6441 9788-0 · Fax +49 6441 9788-17  
www.sensitec.com · sensitec@sensitec.com

