

# GF708

## MagnetoResistive Magnetic Field Sensor

The GF708 is a magnetic field sensor based on the GiantMagnetoResistive (GMR) effect. Its functional magnetic layer is pinned within a synthetic spin-valve connected as a Wheatstone bridge. With its on-chip flux concentrators an extremely large sensitivity can be achieved, resulting in an almost step-like bipolar transfer curve. This way the sensor is suitable for two key application fields: On one hand a highly sensitive magnetic field sensor with a sensitivity of 130 mV/V/mT - on the other hand, the sensor can be used as an index sensor for encoders. Here a single magnetic reference pole can be detected with high spatial resolution.

The product is available as bare die with gold terminals. As flipchip or integrated in a SIL6 or LGA-package the device is suitable for SMD assembly.

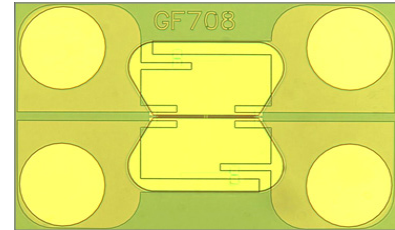

### Product Overview GF708

Article description	Package	Delivery Type
GF708APA-AE	Flip-chip	Tape on reel (2500)
GF708ACA-AB	Die on wafer <sup>1)</sup>	Waferbox
GF708AKA-AC	SIL6	Waffle pack (90)
GF708AMA-AE	LGA6S	Tape on reel (2500)

<sup>1)</sup> Minimum order quantities apply.

### Quick Reference Guide

Symbol	Parameter	Min.	Typ.	Max.	Unit
<b>General</b>					
$V_{CC}$	Supply voltage	-	5.0	-	V
$R_B$	Bridge resistance	13	16	19	k $\Omega$
$T_{amb}$	Ambient temperature	-40	-	+125	$^{\circ}C$
<b>Switching Applications</b>					
$B_{op}$	Magnetic operation range <sup>1)</sup>	-18	-	+18	mT
$B_{switch}$	Magnetic switching range	-1.0	-	+1.0	mT
$V_{range}$	Electrical output range	30	56	70	mV/V
<b>Magnetic Field Applications</b>					
S	Sensitivity	80	130	180	mV/V/mT
$V_{lin}$	Linear range of output voltage	30	40	50	mV/V

<sup>1)</sup> Magnetically unambiguous range.

### Features

- Very high magnetic sensitivity
- Extremely low hysteresis
- Step-like bipolar transfer curve
- Simplified mechanical design, due to in-plane sensitivity
- Available in flip-chip design, SIL6 and LGA housing

### Advantages for Magnetic Switching Applications

- Large air gap
- Large air gap tolerances
- High switching accuracy
- Easy identification of field direction
- Simple integration
- Allows use of small magnets

### Advantages for Magnetic Field Measurement Applications

- Allows detection of smaller particles or material defects (NDT)
- Large distance to target
- High resolution for magnetic imaging



### Absolute Maximum Ratings

In accordance with the absolute maximum rating system (IEC60134).

Symbol	Parameter	Min.	Max.	Unit
$V_{CC}$	Supply voltage	-9.0	+9.0	V
$T_{amb}$	Ambient temperature	-40	+125	°C
$T_{stg}$	Storage temperature (bare die)	-65	+150	°C
$V_{ESD}$	HBM <sup>1)</sup> ESD classification level 1a	-	150	V

<sup>1)</sup> Human Body Model ESD classification level according MIL-STD-883.

Stresses beyond those listed under "Absolute maximum ratings" may cause permanent damage to the device. This is a stress rating only and functional operation of the device at these or any other conditions beyond those indicated in the operational sections of this specification is not implied. Exposure to absolute maximum rating conditions for extended periods may affect device reliability. The device however cannot neither be damaged nor are the specified parametrical limits affected by strong magnetic fields within ambient temperature range.

### General Electrical Data

$T_{amb} = 25\text{ °C}$ ; unless otherwise specified.

Symbol	Parameter	Conditions	Min.	Typ.	Max.	Unit
$V_{CC}$	Supply voltage		-	5.0	-	V
$R_B$	Bridge resistance <sup>2)</sup>		13	16	19	kΩ
$TC_{RB}$	Temperature coefficient of $R_B$ <sup>3)</sup>	$T_1 = 30\text{ °C}, T_2 = 85\text{ °C}$	0.08	0.12	0.14	%/K

<sup>2)</sup> Bridge resistance between pads 1 and 3 or 2 and 4. See Fig.1.

<sup>3)</sup>  $TC_{RB} = 100 \cdot \frac{R_{B(T2)} - R_{B(T1)}}{R_{B(T1)} \cdot (T_2 - T_1)}$  with  $T_1 = +30\text{ °C}$ ;  $T_2 = +85\text{ °C}$ .

### General Electrical Data

Symbol	Parameter	Conditions	Min.	Typ.	Max.	Unit
f	Frequency range		1 <sup>4)</sup>	-	-	MHz

<sup>4)</sup> No significant amplitude attenuation.

In Fig. 1 the resistors  $R_{23}$  and  $R_{41}$  are covered by two flux concentrators (shields) to prevent an applied magnetic field from influencing them. Therefore, when a field is applied, the resistors  $R_{12}$  and  $R_{34}$  decrease in resistance, while the other two resistors under the flux concentrator do not. This imbalance leads to the bridge output.

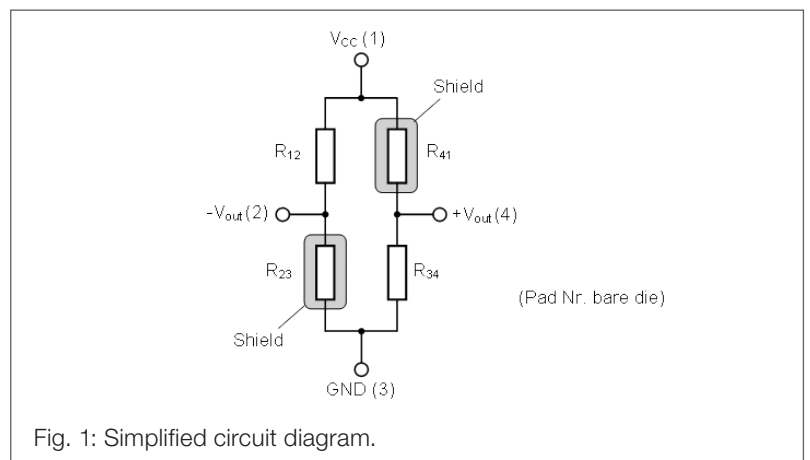
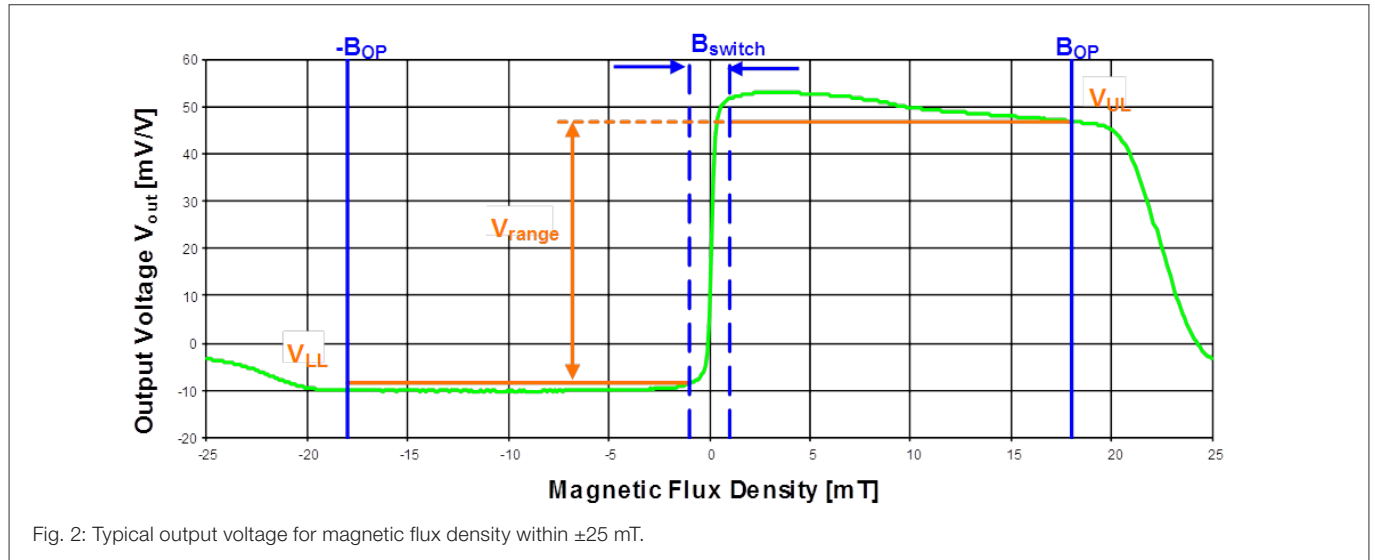

Fig. 1: Simplified circuit diagram.

**Characteristic Transfer Curve Parameters for Switching Applications**

GF708 can ideally be employed as reference sensor or in end-point detection applications. Here, the quasi step-like transfer curve of the incorporated spin-valve is unique within the wide operating range  $B_{op}$  of  $\pm 18$  mT and provides a comfortable electrical operating window  $V_{range}$  of 40 mV/V for the switching threshold.



**Magnetic Data**

Symbol	Parameter	Conditions	Min.	Typ.	Max.	Unit
$B_{switch}$	Magnetic switching range	See Fig. 2	-1.0	-	+1.0	mT
$B_{op}$	Magnetic operation range <sup>1)</sup>	See Fig. 2	-18	-	+18	mT

<sup>1)</sup> Magnetically unambiguous range.

**General Electrical Data**

$T_{amb} = 25$  °C; unless otherwise specified.

Symbol	Parameter	Conditions	Min.	Typ.	Max.	Unit
$V_{UL}$	Upper limit of electrical output range <sup>2)</sup>	See Fig. 2	20	30	40	mV/V
$V_{LL}$	Lower limit of electrical output range <sup>3)</sup>	See Fig. 2	-25	-12	-2	mV/V
$V_{range}$	Electrical output range	See Fig. 2	30	45	60	mV/V
$TC_{V_{range}}$	Temperature coefficient of $V_{range}$ <sup>4)</sup>	$T_1 = 25$ °C, $T_2 = 85$ °C	-0.5	-0.35	-0.2	%/K
$TC_{V_{LL}}$	Temperature coefficient of $V_{LL}$ <sup>5)</sup>	$T_1 = 25$ °C, $T_2 = 85$ °C	-20	15	50	$\mu$ V/V/K

<sup>2)</sup> The upper limit of the electrical output range is defined as the minimum output voltage in the range (1mT, 18mT).

<sup>3)</sup> The lower limit of the electrical output range is defined as the maximum output voltage in the range (-1mT, -18mT).

<sup>4)</sup>  $TC_{V_{range}} = 100 \cdot \frac{V_{range(T_2)} - V_{range(T_1)}}{V_{range(T_1)} \cdot (T_2 - T_1)}$  with  $T_1 = +25$  °C;  $T_2 = +85$  °C.

<sup>5)</sup>  $TC_{V_{LL}} = 100 \cdot \frac{V_{LL(T_2)} - V_{LL(T_1)}}{T_2 - T_1}$  with  $T_1 = +25$  °C;  $T_2 = +85$  °C.

$V_{LL}$  is always negative within the specified ambient temperature range.

**Characteristic Transfer Curve Parameters for Highly Sensitive Magnetic Field Measurement**

GF708 also serves as a highly sensitive magnetic field sensor. Due to the spin-valve technology the transfer curve within ±1 mT features an extremely high sensitivity of 130 mV/V/mT with very low coercivity at the same time. Thus the sensor is ideally suited for e. g. magnetic particle detection, non-destructive testing applications or vehicle detection. Furthermore, the sensor can also be used as an index sensor on encoders.

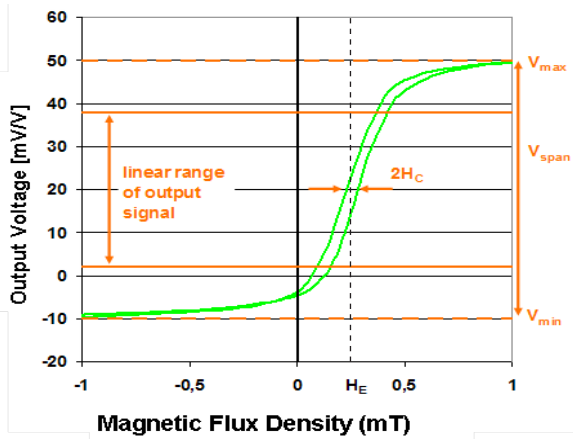

Fig. 3: Typical output voltage for magnetic flux density. within ±1 mT.

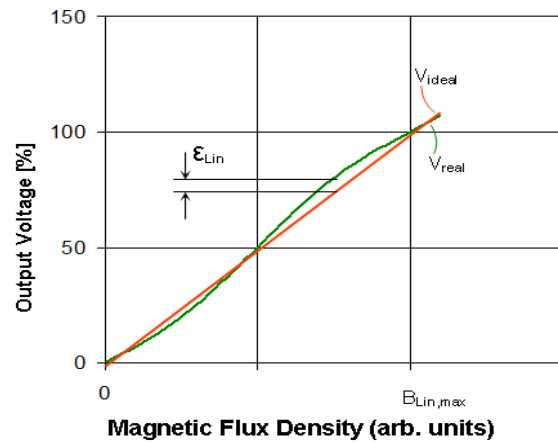

Fig. 4: Definition of linearity error  $\epsilon_{Lin}^{(1)}$  (schematic).

<sup>1)</sup> Linearity error is normalized to the output voltage span  $V_{span} = V_{max} - V_{min}$ .

**Magnetic Data**

Symbol	Parameter	Conditions	Min.	Typ.	Max.	Unit
$H_E$	Exchange coupling <sup>2)</sup>	See Fig. 3	0	0.11	0.2	mT

<sup>2)</sup>  $H_E$  is the exchange coupling field for the GMR spin valve.

**General Electrical Data**

$T_{amb} = 25\text{ °C}$ ; unless otherwise specified.

Symbol	Parameter	Conditions	Min.	Typ.	Max.	Unit
$V_{lin}$	Linear range of output voltage <sup>3)</sup>	See Fig. 3	25	35	45	mV/V
S	Sensitivity	for B = -5 to +5 mT	80	130	180	mV/V/mT
$TC_S$	Temperature coefficient of sensitivity <sup>4)</sup>	$T_1 = 25\text{ °C}, T_2 = 85\text{ °C}$	-0.5	-0.24	-0.00	%/K

<sup>3)</sup> The linear range of the out signal is defined as the interval  $[V_{min} + 0.2 \cdot V_{span}; V_{max} - 0.2 \cdot V_{span}]$ .

<sup>4)</sup>  $TC_S = 100 \cdot \frac{S_{(T_2)} - S_{(T_1)}}{S_{(T_1)} \cdot (T_2 - T_1)}$  with  $T_1 = +25\text{ °C}; T_2 = +85\text{ °C}$ .

**Accuracy**

$T_{amb} = 25\text{ °C}$ ; unless otherwise specified.

Symbol	Parameter	Conditions	Min.	Typ.	Max.	Unit
$H_C$	Hysteresis (Coercivity)	For B = -5 to +5 mT (see Fig. 3)	-	0.05	0.1	mT
$\epsilon_{Lin}$	Linearity error <sup>5)</sup>	See Fig. 4	0	6	10	%

<sup>5)</sup> Linearity error is normalized to the output voltage span  $V_{span} = V_{max} - V_{min}$ .

## GF708 as Bare Die and Flip-Chip

### Pinning

Pad	Symbol	Parameter
1	$V_{CC}$	Supply voltage
2	$-V_{out}$	Negative output voltage
3	GND	Ground
4	$+V_{out}$	Positive output voltage

Note:

The orientation for the pinout of the bare die is given by product label.

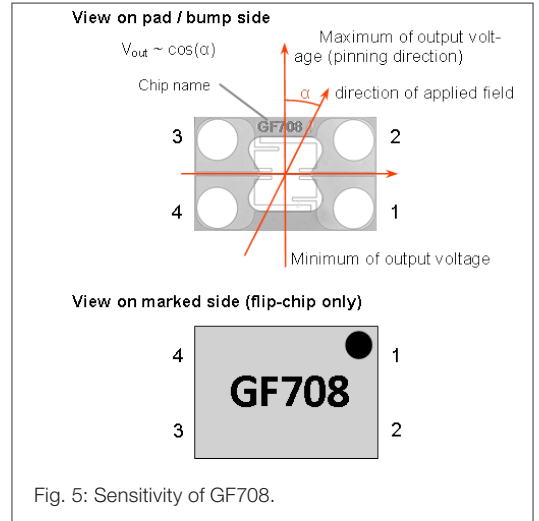

Fig. 5: Sensitivity of GF708.

Fig. 5:  
Bottom: Backside view on laser mark with pin1 indication.

### Dimensions

Symbol	Parameter	Min.	Typ.	Max.	Unit	
A	Bare die	Length	1420	1460	1500	$\mu\text{m}$
B		Width	920	960	1000	$\mu\text{m}$
C		Height	240	250	260	$\mu\text{m}$
d		Diameter	-	230	-	$\mu\text{m}$
A	Flip-chip	Length	1350	1400	1450	$\mu\text{m}$
B		Width	850	900	950	$\mu\text{m}$
C		Height	400	410	420	$\mu\text{m}$
d		Diameter <sup>1)</sup>	-	300	-	$\mu\text{m}$
S		Standoff <sup>2)</sup>	-	240	-	$\mu\text{m}$
a	Pitch a	-	1000	-	$\mu\text{m}$	
b	Pitch b	-	500	-	$\mu\text{m}$	
e	Margin	-	200	-	$\mu\text{m}$	

<sup>1)</sup> Solder ball diameter before reflow.

<sup>2)</sup> After reflow.

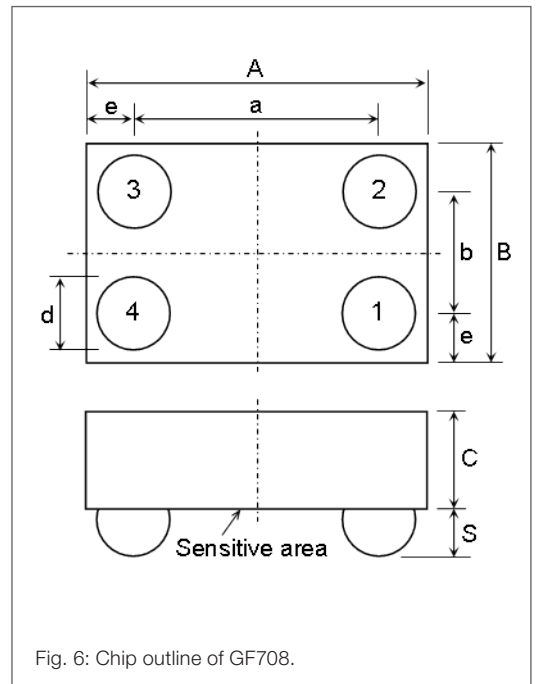

Fig. 6: Chip outline of GF708.

### Data for Packaging and Interconnection Technologies

Symbol	Parameter	Conditions	Value	Unit
Bare die	Pad material		Au	-
	Pad thickness		0.4	$\mu\text{m}$
Flip-chip	Solder ball material		SnAg2.6Cu0.6	-
	Maximum solder temperature	For 6 s	260	$^{\circ}\text{C}$

## GF708AKA SIL6 Package

### Pinning

Pad	Symbol	Parameter
1	GND	Ground
2	nc	Not connected
3	+V <sub>out</sub>	Positive output voltage
4	V <sub>CC</sub>	Supply voltage
5	nc	Not connected
6	-V <sub>out</sub>	Negative output voltage

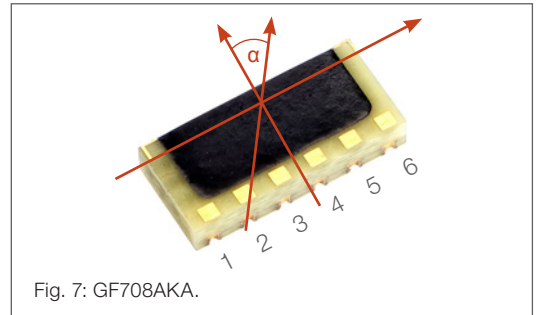

### Dimensions

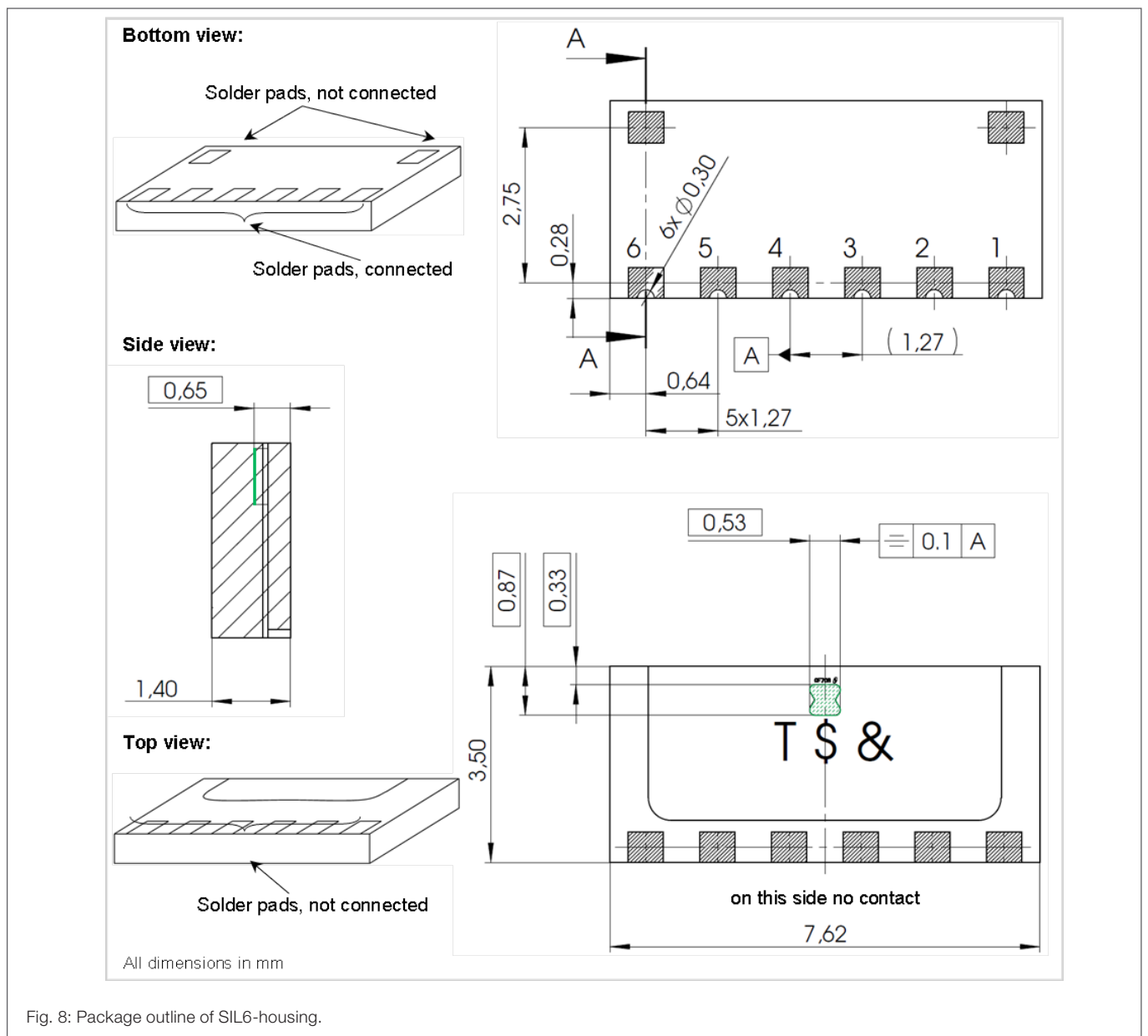

**GF708AMA LGA6S**

**Pinning**

Pad	Symbol	Parameter
1	+V <sub>01</sub>	Positive output voltage bridge 1
2	NC	Not connected
3	GND	Ground
4	V <sub>CC</sub>	Supply voltage
5	-V <sub>01</sub>	Negative output voltage bridge 1
6-8	NC	Not connected

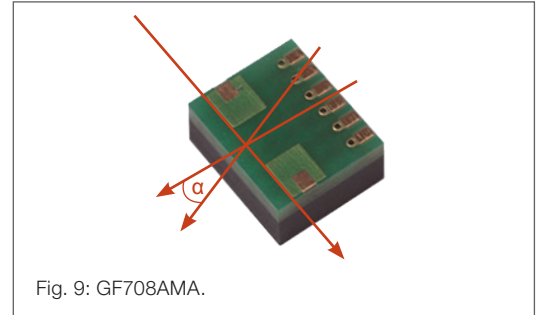

Fig. 9: GF708AMA.

**Dimensions**

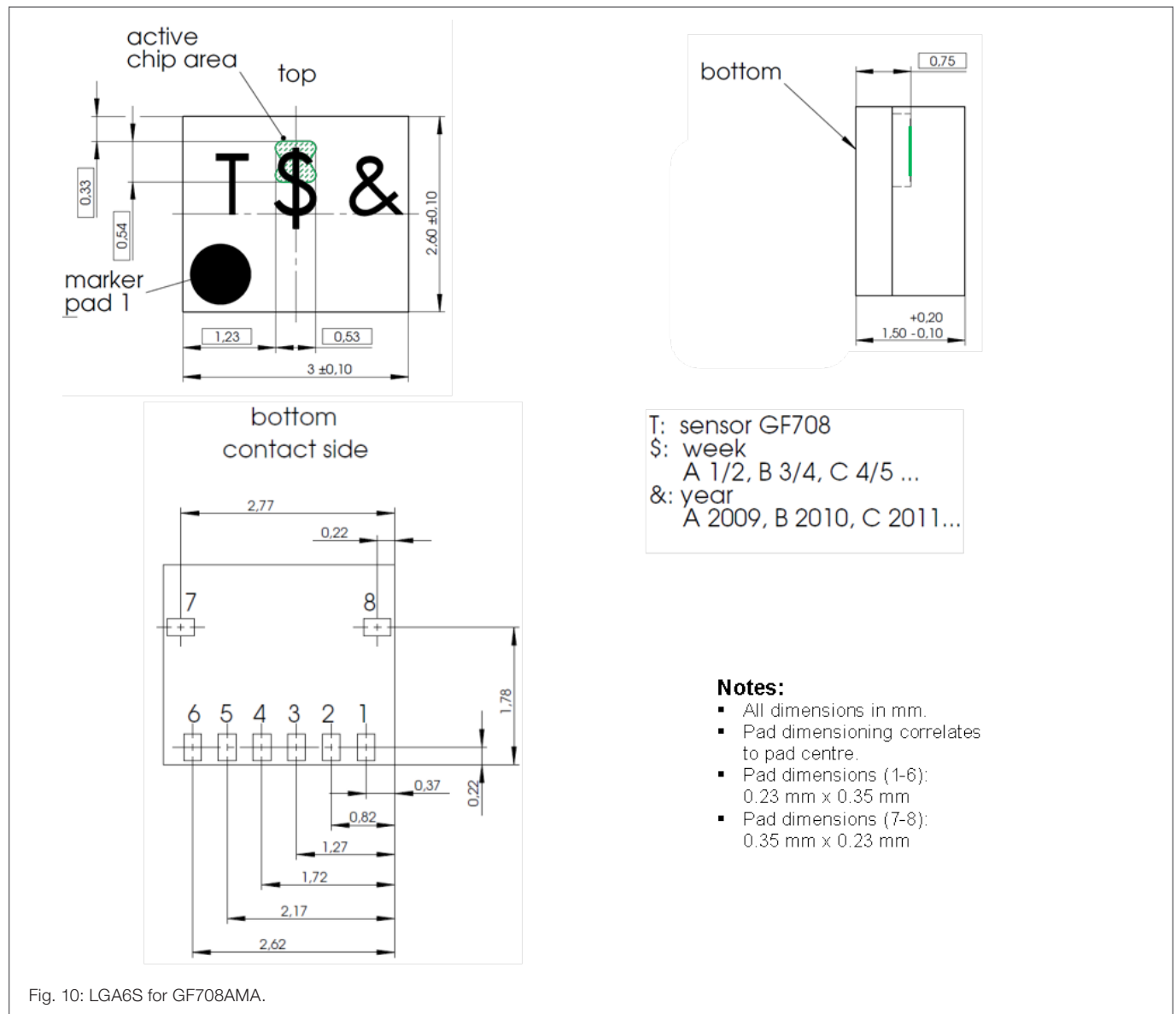

Fig. 10: LGA6S for GF708AMA.

## General Information

### Product Status

Article	Status
GF708APA-AE	The product is undergoing qualification tests. Deliverables have a sample status. The datasheet is preliminary.
GF708ACA-AB	The product is undergoing qualification tests. Deliverables have a sample status. The datasheet is preliminary.
GF708AKA-AC	The product is undergoing qualification tests. Deliverables have a sample status. The datasheet is preliminary.
GF708AMA-AE	The product is undergoing qualification tests. Deliverables have a sample status. The datasheet is preliminary.
<b>Note</b>	The status of the product may have changed since this data sheet was published. The latest information is available on the internet at <a href="http://www.sensitec.com">www.sensitec.com</a> .

### Disclaimer

Sensitec GmbH reserves the right to make changes, without notice, in the products, including software, described or contained herein in order to improve design and/or performance. Information in this document is believed to be accurate and reliable. However, Sensitec GmbH does not give any representations or warranties, expressed or implied, as to the accuracy or completeness of such information and shall have no liability for the consequences of use of such information. Sensitec GmbH takes no responsibility for the content in this document if provided by an information source outside of Sensitec products.

In no event shall Sensitec GmbH be liable for any indirect, incidental, punitive, special or consequential damages (including but not limited to lost profits, lost savings, business interruption, costs related to the removal or replacement of any products or rework charges) irrespective the legal base the claims are based on, including but not limited to tort (including negligence), warranty, breach of contract, equity or any other legal theory.

Notwithstanding any damages that customer might incur for any reason whatsoever, Sensitec product aggregate and cumulative liability towards customer for the products described herein shall be limited in accordance with the General Terms and Conditions of Sale of Sensitec GmbH. Nothing in this document may be interpreted or construed as an offer to sell products that is open for acceptance or the grant, conveyance or implication of any license under any copyrights, patents or other industrial or intellectual property rights.

Unless otherwise agreed upon in an individual agreement Sensitec products sold are subject to the General Terms and Conditions of Sales as published at [www.sensitec.com](http://www.sensitec.com).

#### Sensitec GmbH

Georg-Ohm-Str. 11 · 35633 Lahnau · Germany  
 Tel. +49 6441 9788-0 · Fax +49 6441 9788-17  
[www.sensitec.com](http://www.sensitec.com) · [sensitec@sensitec.com](mailto:sensitec@sensitec.com)



## General Information

### Application Information

Applications that are described herein for any of these products are for illustrative purposes only. Sensitec GmbH makes no representation or warranty – whether expressed or implied – that such applications will be suitable for the specified use without further testing or modification.

Customers are responsible for the design and operation of their applications and products using Sensitec products, and Sensitec GmbH accepts no liability for any assistance with applications or customer product design. It is customer's sole responsibility to determine whether the Sensitec product is suitable and fit for the customer's applications and products planned, as well as for the planned application and use of customer's third party customer(s). Customers should provide appropriate design and operating safeguards to minimize the risks associated with their applications and products.

Sensitec GmbH does not accept any liability related to any default, damage, costs or problem which is based on any weakness or default in the customer's applications or products, or the application or use by customer's third party customer(s). Customer is responsible for doing all necessary testing for the customer's applications and products using Sensitec products in order to avoid a default of the applications and the products or of the application or use by customer's third party customer(s).

Sensitec does not accept any liability in this respect.

### Life Critical Applications

These products are not qualified for use in life support appliances, aeronautical applications or devices or systems where malfunction of these products can reasonably be expected to result in personal injury.

### Copyright © 2019 by Sensitec GmbH, Germany

All rights reserved. No part of this document may be copied or reproduced in any form or by any means without the prior written agreement of the copyright owner. The information in this document is subject to change without notice. Please observe that typical values cannot be guaranteed. Sensitec GmbH does not assume any liability for any consequence of its use.

#### Sensitec GmbH

Georg-Ohm-Str. 11 · 35633 Lahnau · Germany  
Tel. +49 6441 9788-0 · Fax +49 6441 9788-17  
www.sensitec.com · sensitec@sensitec.com