

Current Sensor

Product Series: STK-616Y

Part number: STK-616Y-20B3, STK-616Y-20B5
STK-616Y-30B3, STK-616Y-30B5, STK-616Y-30U3
STK-616Y-40B3
STK-616Y-50B3, STK-616Y-50B5

Version: Ver 4.1

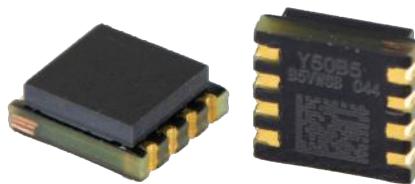

CONTENT

1.	Introduction	2
2.	Package: SOIC8 compatible	2
3.	Selection Guide	3
4.	Production Information	3
5.	Electrical data STK-616Y-xxB5	4
6.	Electrical data STK-616Y-xxB3	4
7.	Electrical data STK-616Y-xxU5	5
8.	Electrical data STK-616Y-xxU3	5
9.	Typical Application Circuit	6
10.	Characteristic Definitions	6
11.	Continues current vs working temperature	6
12.	Dimension & Pin Definitions	7
13.	Frequency band width	8
14.	Step response time	8
15.	Dimension & Pin Definitions	9

1. Introduction

STK-616Y series current sensor is based on TMR (tunnel magnetoresistance) technology, and it has an open-loop design. It is suitable for DC, AC pulsed and any kind of irregular current measurement under the isolated conditions.

Typical applications

- AC variable speed drives
- Motor control
- Switching power supply

General parameter

Parameter	Symbol	Unit	Value
Working temperature	T _A	°C	-40 ~ 105
Storage temperature	T _{stg}	°C	-40 ~ 125
Mass	m	g	0.2

Absolute maximum rating

Parameter	Symbol	Unit	Value
Supply voltage	V _{CC}	V	6
ESD rating (HBM)	U _{ESD}	kV	4

Remark: the unrecoverable damage may occur when the product works on the conditions over the absolute maximum ratings. Long-time working on the absolute maximum ratings may cause the degradation on performance and reliability.

Isolation parameter

Parameter	Symbol	Unit	Value	Comment
RMS voltage for AC test 50Hz/1 min	U _d	kV	2.4	All
Clearance distance (Shortest distance through air)	d _{Cl}	mm	3.5	All
Creepage distance (Shortest path along device body)	d _{Cp}	mm	3.5	All

2. Package: SOIC8 compatible

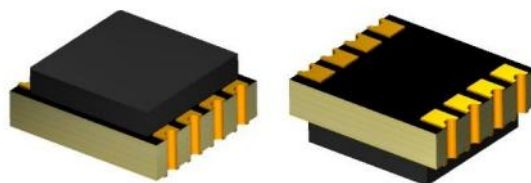

3. Selection Guide

Part Number	Vcc(V)	Current Range (A)	Sensitivity (mV/A)	Offset (V)	Current Directionality	Top(°C)
STK-616Y-20B3	3.3	±20	66	1.65	Bidirectional	-40~105
STK-616Y-20B5	5	±20	100	2.5	Bidirectional	-40~105
STK-616Y-30B3	3.3	±30	44	1.65	Bidirectional	-40~105
STK-616Y-30U3	3.3	30	88	0.33	Unidirectional	-40~105
STK-616Y-30B5	5	±30	66	2.5	Bidirectional	-40~105
STK-616Y-40B3	3.3	±40	33	1.65	Bidirectional	-40~105
STK-616Y-50B3	3.3	±50	26.4	1.65	Bidirectional	-40~105
STK-616Y-50B5	5	±50	40	2.5	Bidirectional	-40~105

4. Production Information

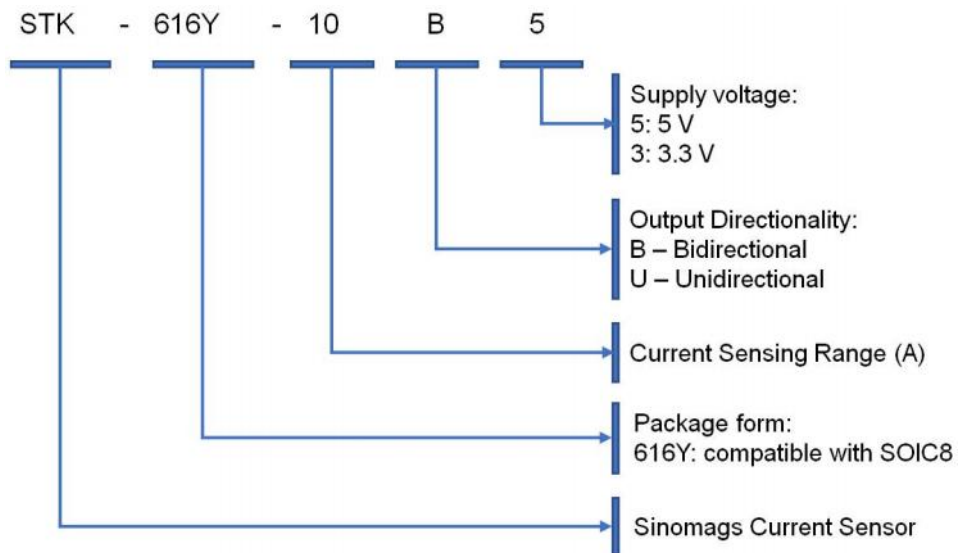

5. Electrical data STK-616Y-xxB5

 Condition: $T_A = 25^{\circ}\text{C}$, $V_{CC} = 5\text{ V}$

Parameter	Symbol	Unit	Min	Typ	Max	Comment
Supply voltage	V_{CC}	V		5±5%		STK-616Y-XXB5
Current consumption	I_{CC}	mA		6		STK-616Y-XXB5
Primary conductor resistance	R_{pr}	mΩ		0.4		STK-616Y-XXB5
Quiescent voltage Vout @ 0 A	$V_{IOUT(Q)}$	V		2.5±0.05		STK-616Y-XXB5
Peak output voltage (Vout @ ±I _{pm}) - $V_{IOUT(Q)}$	V_{FS}	V		±2		STK-616Y-XXB5
Internal output resistance	R_{out}	Ω		2		STK-616Y-XXB5
Rated linearity error	E_{LIN}	% I _{PN}		±1		±I _{PN}
Step response time	t_{res}	μs		2.5		All
Frequency bandwidth (-3dB)	BW	kHz		150		All
Output voltage noise DC ~ 10 kHz DC ~ 100 kHz	V_{noise}	mVpp		20 40		All
Accuracy @ 25°C	E_{TOT}	% of I _{PN}		±1.5		All
Accuracy @ -40°C ~ 105°C	E_{TOT}	% of I _{PN}		±3.5		All

6. Electrical data STK-616Y-xxB3

 Condition: $T_A = 25^{\circ}\text{C}$, $V_{CC} = 3.3\text{ V}$

Parameter	Symbol	Unit	Min	Typ	Max	Comment
				3.3±5%		STK-616Y-XXB3
Current consumption	I_{CC}	mA		6		STK-616Y-XXB5
Primary conductor resistance	R_{pr}	mΩ		0.4		STK-616Y-XXB3
Quiescent voltage Vout @ 0 A				1.65±0.05		STK-616Y-XXB3
Peak output voltage (Vout @ ±I _{pm}) - $V_{IOUT(Q)}$				±1.32		STK-616Y-XXB3
Internal output resistance	R_{out}	Ω		2		STK-616Y-XXB5
Rated linearity error	E_{LIN}	% I _{PN}		±1		±I _{PN}
Step response time	t_{res}	μs		2.5		All
Frequency bandwidth (-3dB)	BW	kHz		150		All
Output voltage noise DC ~ 10 kHz DC ~ 100 kHz	V_{noise}	mVpp		20 40		All
Accuracy @ 25°C	E_{TOT}	% of I _{PN}		±1.5		All
Accuracy @ -40°C ~ 105°C	E_{TOT}	% of I _{PN}		±3.5		All

7. Electrical data STK-616Y-xxU5

 Condition: $T_A = 25^{\circ}\text{C}$, $V_{CC} = 5\text{V}$

Parameter	Symbol	Unit	Min	Typ	Max	Comment
Supply voltage	V_{CC}	V		5±5%		STK-616Y-XXU5
Current consumption	I_{CC}	mA		6		STK-616Y-XXU5
Primary conductor resistance	R_{pr}	mΩ		0.4		STK-616Y-XXU5
Quiescent voltage $V_{out @ 0\text{A}}$				0.5±0.05		STK-616Y-XXU5
Peak output voltage ($V_{out @ \pm I_{pm}} - V_{IOUT(Q)}$)				4		STK-616Y-XXU5
Internal output resistance	R_{out}	Ω		2		
Rated linearity error	E_{LIN}	% I_{PN}		±1		± I_{PN}
Step response time	t_{res}	μs		2.5		All
Frequency bandwidth (-3dB)	BW	kHz		150		All
Output voltage noise DC ~ 10 kHz DC ~ 100 kHz	V_{noise}	mVpp		20 40		All
Accuracy @ 25°C	E_{TOT}	% of I_{PN}		±1.5		All
Accuracy @ -40°C ~ 105°C	E_{TOT}	% of I_{PN}		±3.5		All

8. Electrical data STK-616Y-xxU3

 Condition: $T_A = 25^{\circ}\text{C}$, $V_{CC} = 3.3\text{V}$

Parameter	Symbol	Unit	Min	Typ	Max	Comment
Supply voltage	V_{CC}	V		3.3±5%		STK-616Y-XXU3
Current consumption	I_{CC}	Ma		6		STK-616Y-XXU5
Primary conductor resistance	R_{pr}	MΩ		0.4		STK-616Y-XXU5
Quiescent voltage $V_{out @ 0\text{A}}$				0.33±0.05		STK-616Y-XXU3
Peak output voltage ($V_{out @ \pm I_{pm}} - V_{IOUT(Q)}$)				2.64		STK-616Y-XXU3
Internal output resistance	R_{out}	Ω		2		
Rated linearity error	E_{LIN}	% I_{PN}		±1		± I_{PN}
Step response time	t_{res}	μs		2.5		All
Frequency bandwidth (-3Db)	BW	kHz		150		All
Output voltage noise DC ~ 10 kHz DC ~ 100 kHz	V_{noise}	mVpp		20 40		All
Accuracy @ 25°C	E_{TOT}	% of I_{PN}		±1.5		All
Accuracy @ -40°C ~ 105°C	E_{TOT}	% of I_{PN}		±3.5		All

9. Typical Application Circuit

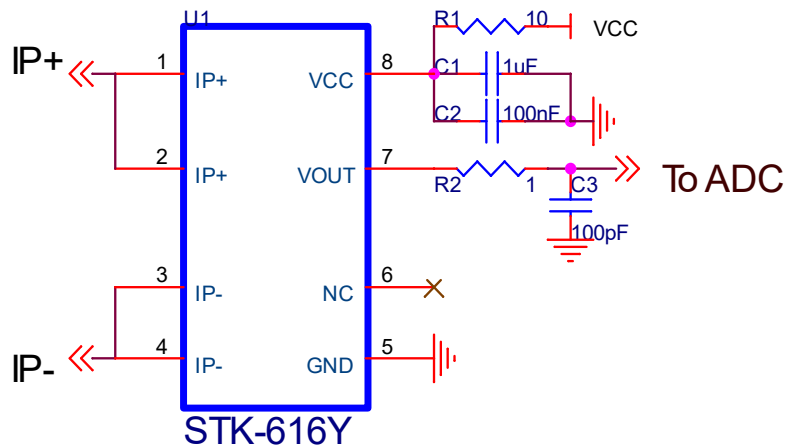

10. Characteristic Definitions

SENSITIVITY (Sens)

The change in sensor output in response to a 1 A change through the primary conductor. The sensitivity is the sensor gain (mV/A) for the full-scale current of the device. The sensitivity is fixed and does not change with the supply voltage.

ZERO CURRENT OUTPUT VOLTAGE (VIOUT(Q))

The output of the sensor when the primary current is zero. When the power supply is 5 V, it nominally remains at 2.5 V for a bidirectional device. When the power supply is 3.3 V, it nominally remains at 1.65 V for a bidirectional device.

11. Continues current vs working temperature

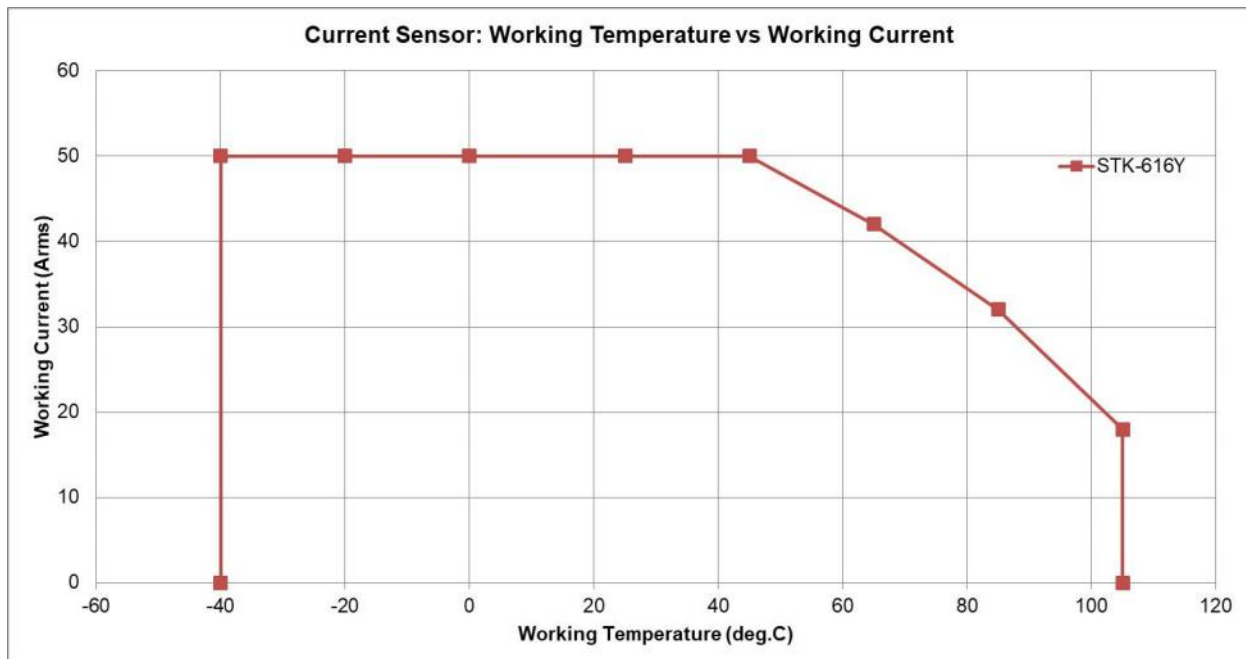

12. Dimension & Pin Definitions

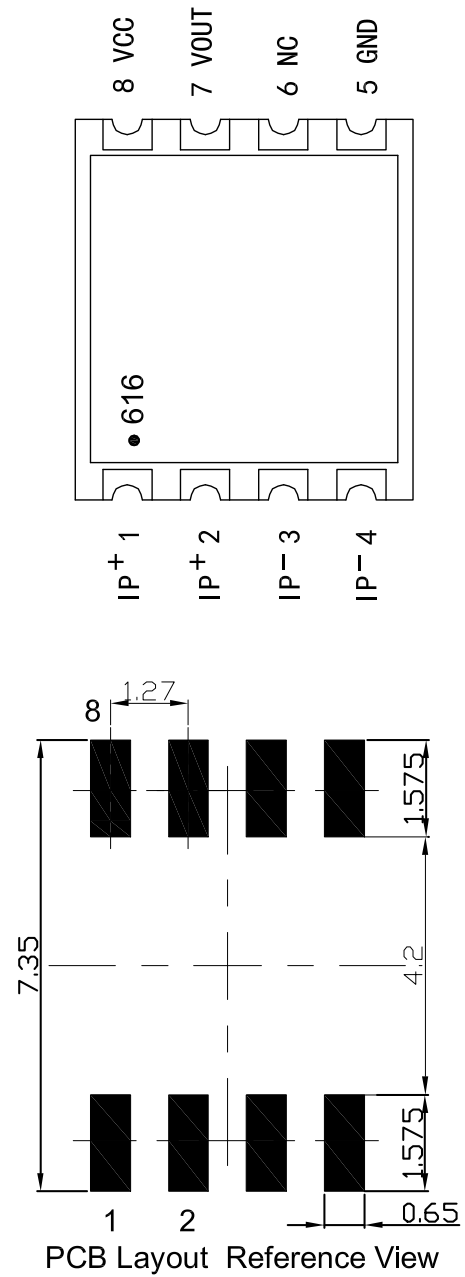
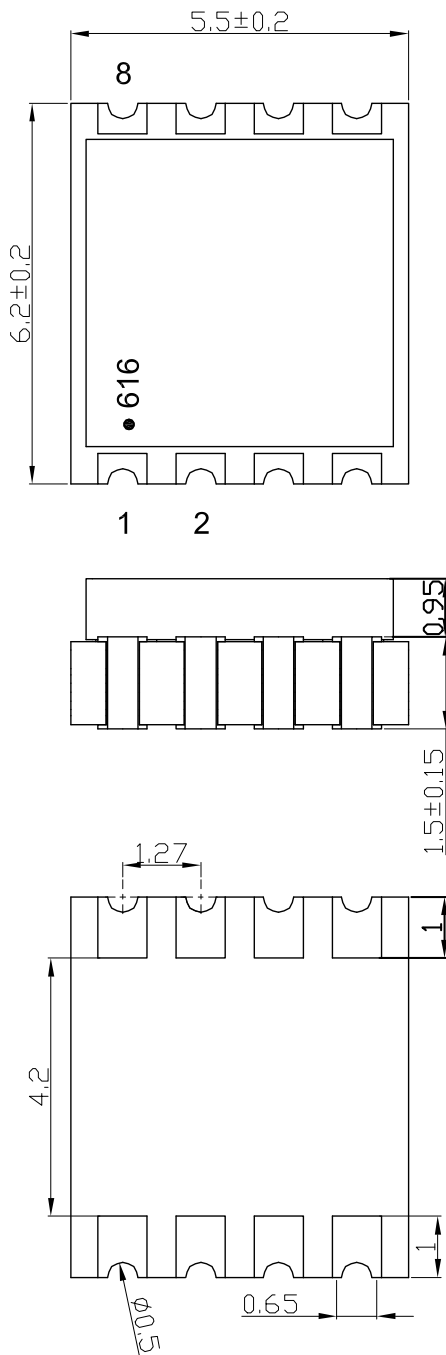

13. Frequency band width

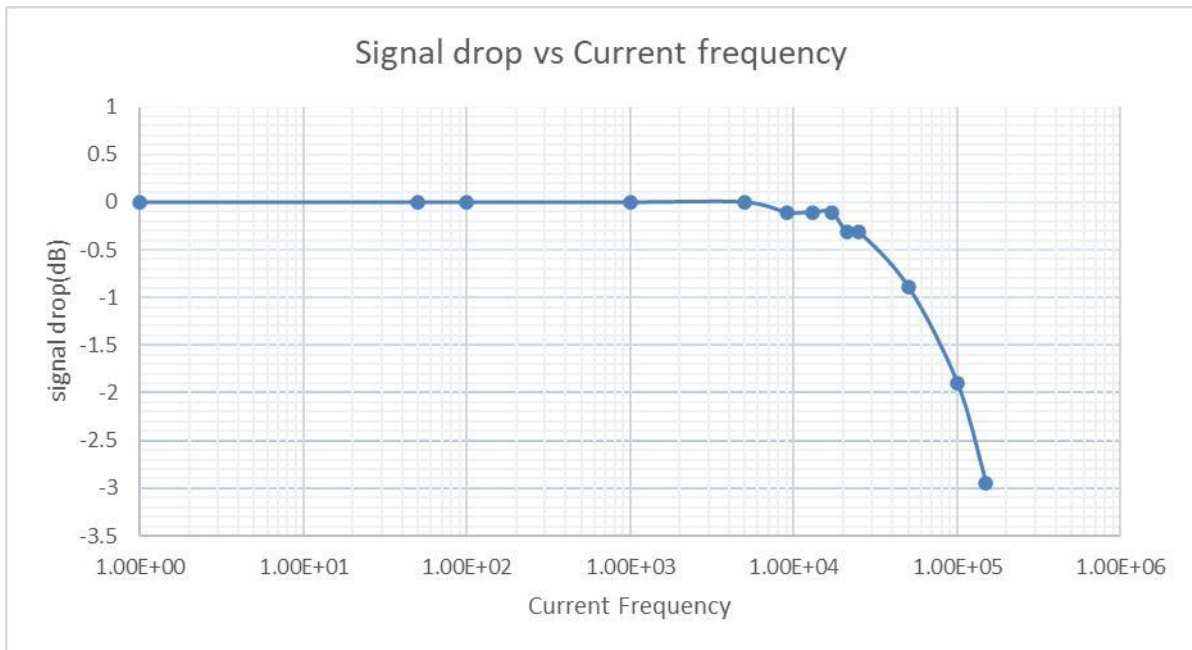

14. Step response time

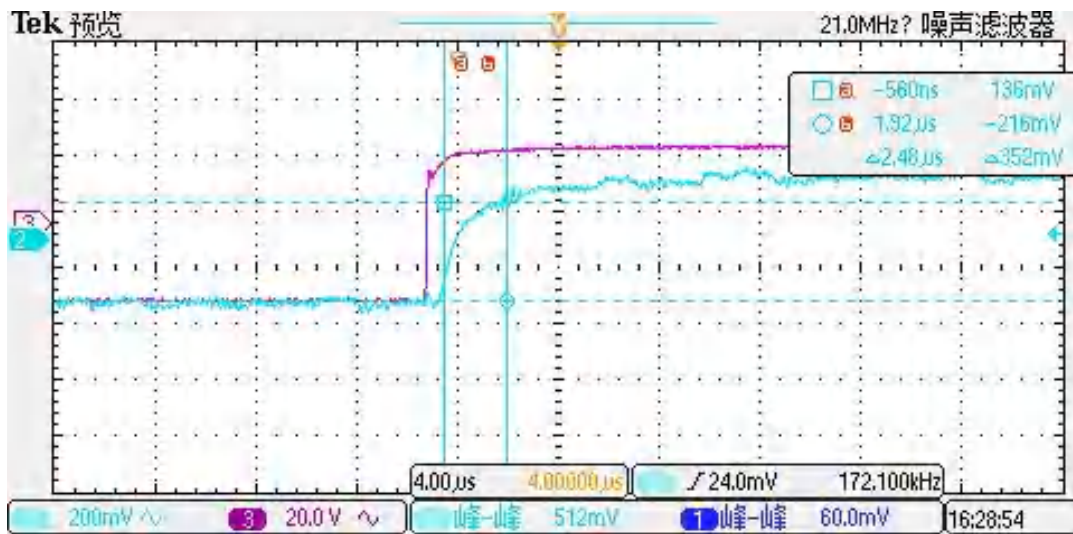

The typical frequency response of STK-616Y current sensor. The response time from 90% of the primary current (pink) to 90% of the secondary output (blue) is 2.48 μs.

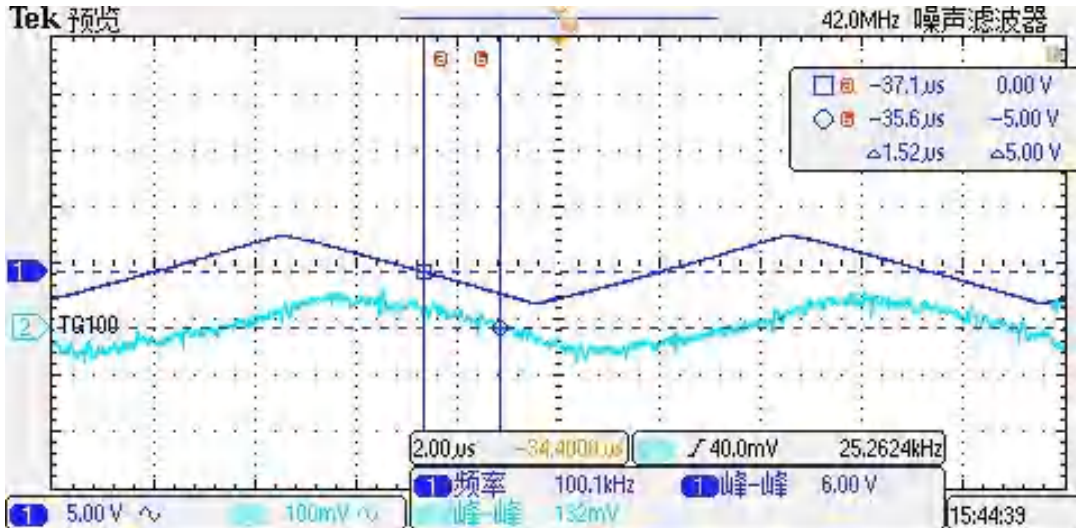

The typical frequency response of STK-616Y current sensor. The delay of output to the primary triangle current with a frequency of 100 kHz is around 1.52µs.

15. Dimension & Pin Definitions

TAPE AND REEL INFORMATION

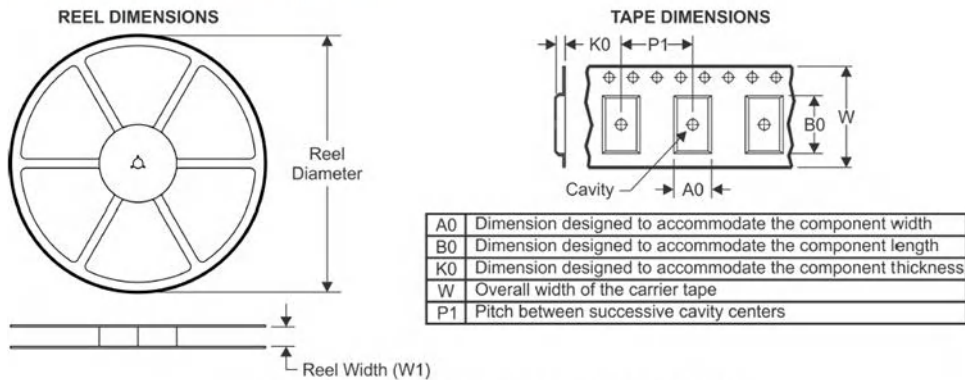

QUADRANT ASSIGNMENTS FOR PIN 1 ORIENTATION IN TAPE

